

pi.effe.ci.



Collari e Accessori
per tubi rigidi





Tubi condotta rigidi

TC-TCZ-TCX Tubi per circuiti oleodinamici

- Trafilati a freddo
- Senza saldatura
- Piegabili a freddo

Caratteristiche generali

TC = BONDERIZZATO

Tolleranza	DIN 2391
Materiali	Acciaio TC ST 37,4 Bonderizzato
	TCZ ST 37,4 Zincato esternamente
	Inox TCX AISI 316
Trattamenti	ricotti in atmosfera inerte, normalizzati, fosfatati, decappati, esecuzione NBK, marchiati su tutta la lunghezza
Controlli	con sistema elettromagnetico (Eddy current)
Lunghezza	Verga da 6 metri (3 mt per tubo inox TCX)
Fornitura	Multipli di 6 metri (si eseguono tagli da 2 e 3 m)

TCZ = ZINCATO

ST 37,4		AISI 316 inox	misura		pressione di esercizio/bar f.s. = 2
Bonderizzato	Zincato		Ø est. mm	spessore mm	
TC	TCZ	TCX	4	x 1	540
TC	TCZ	TCX	6	x 1	360
TC	TCZ		6	x 1,5	540
TC	TCZ	TCX	8	x 1	270
TC	TCZ	TCX	8	x 1,5	405
TC	TCZ	TCX	10	x 1	216
TC	TCZ	TCX	10	x 1,5	324
TC	TCZ	TCX	10	x 2	432
TC	TCZ	TCX	12	x 1	180
TC	TCZ	TCX	12	x 1,5	270
TC	TCZ		12	x 2	360
TC	TCZ		14	x 1,5	231
TC	TCZ	TCX	14	x 2	308
TC	TCZ	TCX	15	x 1,5	216
TC			15	x 2	288
TC	TCZ		16	x 1,5	202
TC	TCZ	TCX	16	x 2	270
TC			16	x 2,5	337
TC	TCZ		18	x 1,5	180
TC	TCZ		18	x 2	240
TC			18	x 2,5	300
TC			20	x 2	216
TC	TCZ		20	x 2,5	270
TC			20	x 3	324
TC	TCZ		22	x 2	196
TC			25	x 3	259
TC			25	x 4	345
TC	TCZ		28	x 2	154
TC			28	x 3	231
TC	TCZ		30	x 3	216
TC			30	x 4	288
TC	TCZ		35	x 3	185
TC			38	x 3	170
	TCZ		38	x 4	227
TC	TCZ		42	x 3	154

TCX = INOX

Altre misure fornibili a richiesta.



Collari per fissaggio dei tubi rigidi

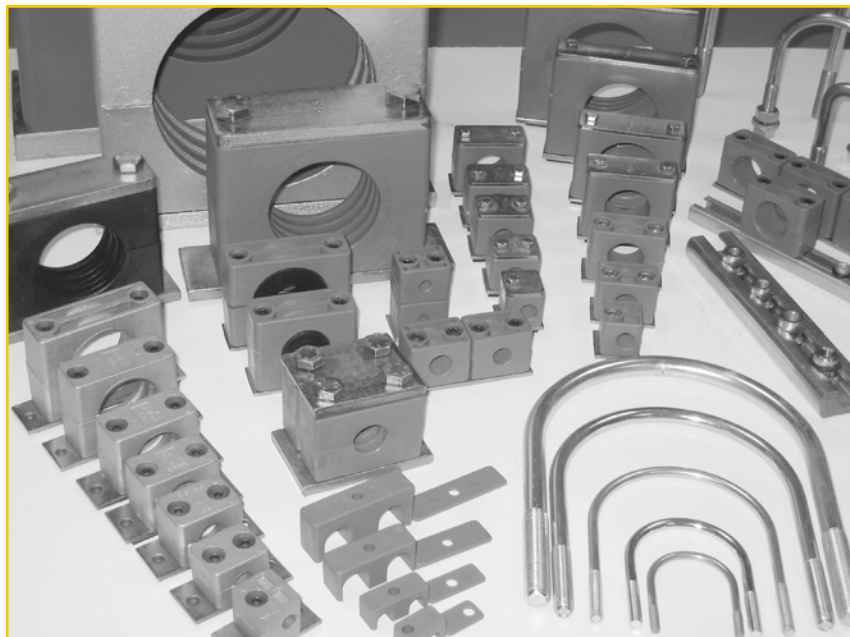

I collari sono elementi indispensabili per il fissaggio delle tubazioni negli innumerevoli settori dell'industria: in particolare negli impianti oleodinamici assorbono i rumori e ammortizzano le vibrazioni.

Vengono fabbricati nella versione standard in Polipropilene adatti per temperature di esercizio fino a 90°C, a richiesta in Poliamide autoestingente per temperature fino a 120°C o in Alluminio per temperature fino a 300°C.

Materiali

Collari	Standard:	PP	Polipropilene ad alta resistenza ed elevata elasticità
	a richiesta:	PA	Poliammide rinforzata con fibra di vetro autoestingente
		A-AL	Lega di alluminio
Bussole e anelli in gomma			Mescola in gomma NBR 70
Piastrine, cavallotti e binari	Standard:		Acciaio zincato bianco
	a richiesta:		Acciaio inox AISI 304 - AISI 316
Viti	Standard:		Acciaio brunito
	a richiesta:		Acciaio zincato bianco, acciaio inox AISI 316L









Tablelle di conversione

TUBI GAS - UNI 8863	
Diametro esterno mm	Diametro esterno Pollici gas
10	1/8"
13,5	1/4"
17,2	3/8"
21,3	1/2"
26,9	3/4"
33,7	1"
42,4	1"1/4
48,3	1"1/2
53,74	1"3/4
60,3	2"
66	2"1/4
76,1	2"1/2
88,9	3"
102	3"1/2
114,3	4"
126,5	4"1/2
139,7	5"
168	6"
219	8"
273	10"
324	12"
356	14"
406	16"

TUBI IN POLLICI INGLES	
Diametro esterno mm	Diametro esterno Pollici inglesi
6,35	1/4"
7,89	5/16"
9,52	3/8"
12,7	1/2"
15,87	5/8"
19,05	3/4"
22,22	7/8"
25,4	1"
31,75	1"1/4
38,1	1"1/2
44,45	1"3/4
50,8	2"
57,2	2"1/4
63,5	2"1/2
70	2"3/4
76,2	3"
82,5	3"1/4
88,9	3"1/2
101,6	4"
108	4"1/4
114,3	4"1/2
127	5"
133	5"1/4
152	6"
159	6"1/4
165	6"1/2
177,8	7"
193,7	7"5/8
203	8"
216	8"1/2

Collari per fissaggio dei tubi rigidi

Serie C Standard

Composizione della versione completa	TIPO misure L x H x P	Codice		diametro esterno tubo		
		Coppia semicollare	Collare completo	mm	pollici GAS	pollici inglesi
	C1 28x28x30	C1 6	C1 6-C	6	-	-
		C1 6,35	C1 6,35-C	6,35	-	1/4"
		C1 8	C1 8-C	8	-	5/16"
		C1 9,52	C1 9,52-C	9,52	-	3/8"
		C1 10	C1 10-C	10	1/8"	-
		C1 12	C1 12-C	12	-	-
		C1 12,7	C1 12,7-C	12,7	-	1/2"
		C1 13,5	C1 13,5-C	13,5	1/4"	-
	C2 37x28x30	C2 6	C2 6-C	6	-	-
		C2 6,35	C2 6,35-C	6,35	-	1/4"
		C2 8	C2 8-C	8	-	5/16"
		C2 9,52	C2 9,52-C	9,52	-	3/8"
		C2 10	C2 10-C	10	1/8"	-
		C2 12	C2 12-C	12	-	-
		C2 12,7	C2 12,7-C	12,7	-	1/2"
		C2 13,5	C2 13,5-C	13,5	1/4"	-
	C3 43x33x30	C3 13,5	C3 13,5-C	13,5	1/4"	-
		C3 14	C3 14-C	14	-	-
		C3 15	C3 15-C	15	-	-
		C3 16	C3 16-C	16	-	5/8"
		C3 17,2	C3 17,2-C	17,2	3/8"	-
	C4 50x36x30	C3 18	C3 18-C	18	-	-
		C4 19	C4 19-C	19	-	3/4"
		C4 20	C4 20-C	20	-	-
		C4 21,3	C4 21,3-C	21,3	1/2"	-
		C4 22	C4 22-C	22	-	7/8"
		C4 23	C4 23-C	23	-	-
	C5 57x44x30	C4 25	C4 25-C	25	-	-
		C4 25,4	C4 25,4-C	25,4	-	1"
		C5 26,9	C5 26,9-C	26,9	3/4"	-
		C5 28	C5 28-C	28	-	-
		C5 30	C5 30-C	30	-	-
		C5 32	C5 32-C	32	-	1"1/4
	C6 69,5x57x30	C6 32	C6 32-C	32	-	1"1/4
		C6 33,7	C6 33,7-C	33,7	1"	-
		C6 35	C6 35-C	35	-	-
		C6 38	C6 38-C	38	-	1"1/2
		C6 40	C6 40-C	40	-	-
		C6 42,4	C6 42,4-C	42,4	1"1/4	-
		C6 45	C6 45-C	45	-	-
	C7 86x66x30	C7 44,5	C7 44,5-C	44,5	-	1"3/4
		C7 45	C7 45-C	45	-	-
		C7 48,3	C7 48,3-C	48,3	1"1/2	-
		C7 50	C7 50-C	50	-	-
		C7 50,8	C7 50,8-C	50,8	-	2"
		C7 54	C7 54-C	54	1"3/4	-
	C8 121x93x30	C8 57,2	C8 57,2-C	57,2	-	2"1/4
		C8 60,3	C8 60,3-C	60,3	2"	-
		C8 63,5	C8 63,5-C	63,5	-	2"1/2
		C8 70	C8 70-C	70	-	2"3/4
		C8 73	C8 73-C	73	-	-
		C8 76,1	C8 76,1-C	76,1	2"1/2	3"
	C9 147x118x30	C9 88,9	C9 88,9-C	88,9	3"	3"1/2
		C9 102	C9 102-C	102	3"1/2	4"



Collari per fissaggio dei tubi rigidi

Serie CB

Standard con bussola in gomma

Composizione della versione completa (*)	TIPO misure L x H x P	Codice		diametro esterno tubo		
		Coppia semicollare	Bussola in gomma	mm	pollici GAS	pollici inglesi
	CB4 50x36x30	CB4	BG06-2531	6	-	-
		CB4	BG08-2531	8	-	5/16"
		CB4	BG10-2531	10	1/8"	-
		CB4	BG12-2531	12	-	-
		CB4	BG13,5-2531	13,5	1/4"	-
		CB4	BG14-2531	14	-	-
		CB4	BG15-2531	15	-	-
		CB4	BG16-2531	16	-	5/8"
		CB4	BG17,2-2531	17,2	3/8"	-
		CB4	BG18-2531	18	-	-
	CB6 69,5x57x30	CB6	BG08-3831	8	-	-
		CB6	BG10-3831	10	1/8"	-
		CB6	BG12-3831	12	-	-
		CB6	BG15-3831	15	-	-
		CB6	BG16-3831	16	-	5/8"
		CB6	BG18-3831	18	-	-
		CB6	BG20-3831	20	-	-
		CB6	BG21,3-3831	21,3	1/2"	-
		CB6	BG22-3831	22	-	7/8"
		CB6	BG25-3831	25	-	-
CB7 86x66x30	CB7	BG26,9-3831	26,9	3/4"	-	
	CB7	BG28-3831	28	-	-	
	CB7	BG30-3831	30	-	-	
	CB7	BG32-3831	32	-	1"1/4	
	CB7	BG28-5731	28	-	-	
	CB7	BG30-5731	30	-	-	
	CB7	BG33,7-5731	33,7	1"	-	
	CB7	BG35-5731	35	-	-	
CB7	BG38-5731	38	-	1"1/2		
CB7	BG40-5731	40	-	-		
CB7	BG42,4-5731	42,4	1"1/4	-		
CB7	BG48,3-5731	48,3	1"1/2	-		

(*) **ATTENZIONE:** I collari con bussola sono forniti sfusi, per ottenere la versione completa ordinare separatamente:

- n° 1 coppia semicollare
- n° 1 bussola in gomma
- n° 1 piastra inferiore **P...** (vedi accessori)
- n° 2 viti **TCEI...** (vedi accessori)
- n° 2 Rondelle **RP** (vedi accessori)

Collari per fissaggio dei tubi rigidi

ACCESSORI

Piastra inferiore

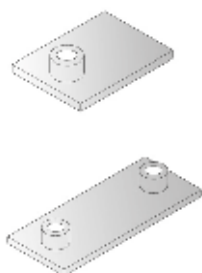

tipo collare	Codice
C1	P1
C2	P2
C3	P3
C4 - CB4	P4
C5	P5
C6 - CB6	P6
C7 - CB7	P7
C8	P8
C9	P9

Piastra superiore



tipo collare	Codice
C1	PS1
C2	PS2
C3	PS3
C4 - CB4	PS4
C5	PS5
C6 - CB6	PS6
C7 - CB7	PS7
C8	PS8
C9	PS9

Piastra inferiore allungata

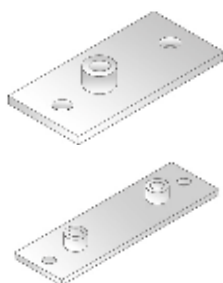

tipo collare	Codice
C1	PL1
C2	PL2
C3	PL3
C4 - CB4	PL4
C5	PL5
C6 - CB6	PL6
C7 - CB7	PL7
C8	PL8
C9	PL9

Piastra inferiore doppia

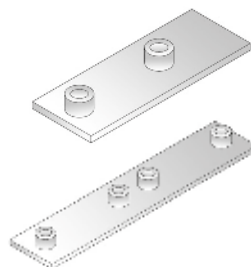

tipo collare	Codice
C1	PD1
C2	PD2
C3	PD3
C4 - CB4	PD4
C5	PD5
C6 - CB6	PD6
C7 - CB7	PD7

*Fornibile a richiesta anche piastre multiple e piastre distanziate.

Vite testa cilindrica con esagono incassato

Per montaggio
con piastra inferiore



tipo collare	Codice	misura
C1 - C2	TCEI1-2	M6x22
C3	TCEI3	M6x28
C4 - CB4	TCEI4	M6x30
C5	TCEI5	M6x40
C6 - CB6	TCEI6	M6x50
C7 - CB7	TCEI7	M6x60
C8	TCEI8	M6x85
C9	TCEI9	M6x110

Vite testa esagonale

Per montaggio
con piastra superiore



tipo collare	Codice	misura
C1 - C2	VE1-2	M6x30
C3	VE3	M6x35
C4 - CB4	VE4	M6x40
C5	VE5	M6x45
C6 - CB6	VE6	M6x60
C7 - CB7	VE7	M6x70
C8	VE8	M6x100
C9	VE9	M6x125

Vite testa esagonale alta con filettatura interna

Per montaggio
di collari sovrapposti



tipo collare	Codice	misura
C1 - C2	VA1-2	M6x20
C3	VA3	M6x25
C4 - CB4	VA4	M6x29
C5	VA5	M6x35
C6 - CB6	VA6	M6x49
C7 - CB7	VA7	M6x59
C8	VA8	M6x85
C9	VA9	M6x110

Piastrina di bloccaggio per VA



tipo collare	Codice	
	singola	doppia
C1		-
C2		PB2
C3		PB3
C4-CB4		PB4
C5	PB (tutti i tipi)	PB5
C6 - CB6		PB6
C7 - CB7		PB7
C8		PB8
C9		PB9

Rondella piana per montaggio senza piastra superiore



misura	Codice
6,3x11,5x1,5	RP-M6



Collari per fissaggio dei tubi rigidi

Serie CF

Standard a 2 tubi

Composizione della versione Completa	Tipo misure L x H x P	Codice		diametro esterno tubo		
		Coppia semicollare	Collare completo	mm	pollici GAS	pollici inglesi
	CF1 36x27x30	CF1 6	CF1 6-C	6	-	-
		CF1 6,35	CF1 6,35-C	6,35	-	1/4"
		CF1 8	CF1 8-C	8	-	5/16"
		CF1 9,52	CF1 9,52-C	9,52	-	3/8"
		CF1 10	CF1 10-C	10	1/8"	-
		CF1 12	CF1 12-C	12	-	-
	CF2 54x27x30	CF2 12,7	CF2 12,7-C	12,7	-	1/2"
		CF2 13,5	CF2 13,5-C	13,5	1/4"	-
		CF2 14	CF2 14-C	14	-	-
		CF2 15	CF2 15-C	15	-	-
		CF2 16	CF2 16-C	16	-	5/8"
		CF2 17,2	CF2 17,2-C	17,2	3/8"	-
	CF3 67x37x30	CF3 18	CF3 18-C	18	-	-
		CF3 19	CF3 19-C	19	-	3/4"
		CF3 20	CF3 20-C	20	-	-
		CF3 21,3	CF3 21,3-C	21,3	1/2"	-
		CF3 22	CF3 22-C	22	-	7/8"
	CF4 81x42x30	CF3 23	CF3 23-C	23	-	-
		CF3 25	CF3 25-C	25	-	-
		CF3 25,4	CF3 25,4-C	25,4	-	1"
CF4 26		CF4 26-C	26	-	-	
CF5 106x53x30	CF4 26,9	CF4 26,9-C	26,9	3/4"	-	
	CF4 28	CF4 28-C	28	-	-	
	CF4 30	CF4 30-C	30	-	-	
	CF5 32	CF5 32-C	32	-	1"1/4	
	CF5 33,7	CF5 33,7-C	33,7	1"	-	
	CF5 35	CF5 35-C	35	-	-	
	CF5 38	CF5 38-C	38	-	1"1/2	
CF5 40	CF5 40-C	40	-	-		
CF5 42,4	CF5 42,4-C	42,4	1"1/4	-		

ACCESSORI

Piastra inferiore

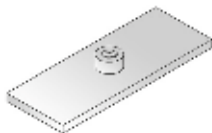

tipo collare	Codice
CF1	P-CF1
CF2	P-CF2
CF3	P-CF3
CF4	P-CF4
CF5	P-CF5

Fornibile a richiesta anche piastre multiple e piastre distanziate

Piastra superiore

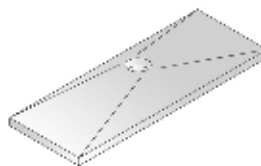

tipo collare	Codice
CF1	PS-CF1
CF2	PS-CF2
CF3	PS-CF3
CF4	PS-CF4
CF5	PS-CF5

Vite testa esagonale per montaggio con piastra superiore



tipo collare	Codice	misura
CF1	TE-CF1	M6x35
CF2	TE-CF2	M8x35
CF3	TE-CF3	M8x45
CF4	TE-CF4	M8x50
CF5	TE-CF5	M8x60

Fornibili a richiesta viti VA per montaggio di collari sovrapposti

Collari per fissaggio dei tubi rigidi

Serie CP

Pesante

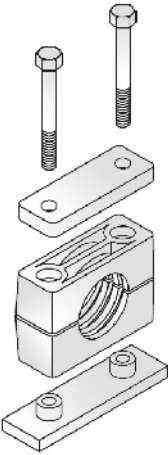
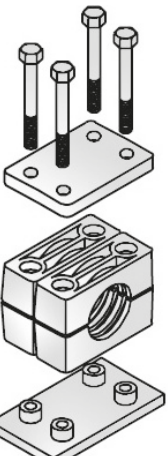
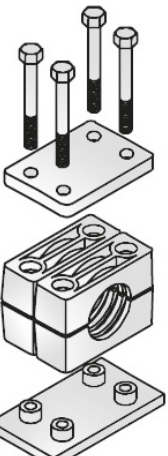
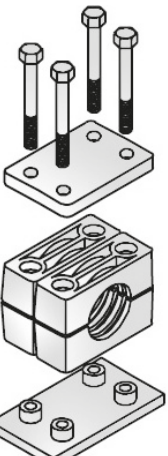
Composizione della versione completa	Tipo misure L x H x P	Codice			diametro esterno tubo				
		Coppia semicollare	Collare completo		mm	pollici GAS	pollici inglesi		
			Singolo	Doppio					
 <p>Singolo</p>	CP1 57x33x30	CP1 6	CP1 6 CS-C	CP1 6 CD-C	6	-	-		
		CP1 6,35	CP1 6,35 CS-C	CP1 6,35 CD-C	6,35	-	1/4"		
		CP1 8	CP1 8 CS-C	CP1 8 CD-C	8	-	-		
		CP1 9,52	CP1 9,52 CS-C	CP1 9,52 CD-C	9,52	-	3/8"		
		CP1 10	CP1 10 CS-C	CP1 10 CD-C	10	1/8"	-		
		CP1 12	CP1 12 CS-C	CP1 12 CD-C	12	-	-		
		CP1 12,7	CP1 12,7 CS-C	CP1 12,7 CD-C	12,7	-	1/2"		
		CP1 13,5	CP1 13,5 CS-C	CP1 13,5 CD-C	13,5	1/4"	-		
		CP1 14	CP1 14 CS-C	CP1 14 CD-C	14	-	-		
		CP1 15	CP1 15 CS-C	CP1 15 CD-C	15	-	-		
		CP1 16	CP1 16 CS-C	CP1 16 CD-C	16	-	5/8"		
		CP1 17,2	CP1 17,2 CS-C	CP1 17,2 CD-C	17,2	3/8"	-		
		CP1 18	CP1 18 CS-C	CP1 18 CD-C	18	-	-		
		CP1 19	CP1 19 CS-C	CP1 19 CD-C	19	-	3/4"		
		CP1 20	CP1 20 CS-C	CP1 20 CD-C	20	-	-		
		 <p>Doppio</p>	CP2 69x49x30	CP2 19	CP2 19 CS-C	CP2 19 CD-C	19	-	3/4"
				CP2 20	CP2 20 CS-C	CP2 20 CD-C	20	-	-
				CP2 21,3	CP2 21,3 CS-C	CP2 21,3 CD-C	21,3	1/2"	-
				CP2 22	CP2 22 CS-C	CP2 22 CD-C	22	-	7/8"
				CP2 25	CP2 25 CS-C	CP2 25 CD-C	25	-	-
CP2 25,4	CP2 25,4 CS-C			CP2 25,4 CD-C	25,4	-	1"		
CP2 26,9	CP2 26,9 CS-C			CP2 26,9 CD-C	26,9	3/4"	-		
CP2 28	CP2 28 CS-C			CP2 28 CD-C	28	-	-		
CP2 30	CP2 30 CS-C			CP2 30 CD-C	30	-	-		
	CP3 84x60x30			CP3 30	CP3 30 CS-C	CP3 30 CD-C	30	-	-
		CP3 32	CP3 32 CS-C	CP3 32 CD-C	32	-	1"1/4		
		CP3 33,7	CP3 33,7 CS-C	CP3 33,7 CD-C	33,7	1"	-		
		CP3 35	CP3 35 CS-C	CP3 35 CD-C	35	-	-		
		CP3 36	CP3 36 CS-C	CP3 36 CD-C	36	-	-		
		CP3 38	CP3 38 CS-C	CP3 38 CD-C	38	-	1"1/2		
		CP3 40	CP3 40 CS-C	CP3 40 CD-C	40	-	-		
		CP3 42,4	CP3 42,4 CS-C	CP3 42,4 CD-C	42,4	1"1/4	-		
		CP3 43	CP3 43 CS-C	CP3 43 CD-C	43	-	-		
		CP3 45	CP3 45 CS-C	CP3 45 CD-C	45	-	-		
	CP4 117x88x45	CP4 33,7	CP4 33,7 CS-C	CP4 33,7 CD-C	33,7	1"	-		
		CP4 38	CP4 38 CS-C	CP4 38 CD-C	38	-	1"1/2		
		CP4 40	CP4 40 CS-C	CP4 40 CD-C	40	-	-		
		CP4 42,4	CP4 42,4 CS-C	CP4 42,4 CD-C	42,4	1"1/4	-		
		CP4 45	CP4 45 CS-C	CP4 45 CD-C	45	-	1"3/4		
		CP4 48,3	CP4 48,3 CS-C	CP4 48,3 CD-C	48,3	1"1/2	-		
		CP4 50	CP4 50 CS-C	CP4 50 CD-C	50	-	-		
		CP4 50,8	CP4 50,8 CS-C	CP4 50,8 CD-C	50,8	-	2"		
		CP4 53	CP4 53 CS-C	CP4 53 CD-C	53	-	-		
		CP4 54	CP4 54 CS-C	CP4 54 CD-C	54	1"3/4	-		
		CP4 55	CP4 55 CS-C	CP4 55 CD-C	55	-	-		
		CP4 56	CP4 56 CS-C	CP4 56 CD-C	56	-	-		
		CP4 57,2	CP4 57,2 CS-C	CP4 57,2 CD-C	57,2	-	2"1/4		
		CP4 60,3	CP4 60,3 CS-C	CP4 60,3 CD-C	60,3	2"	-		
		CP4 63,5	CP4 63,5 CS-C	CP4 63,5 CD-C	63,5	-	2"1/2		
CP4 65	CP4 65 CS-C	CP4 65 CD-C	65	-	-				
CP4 70	CP4 70 CS-C	CP4 70 CD-C	70	-	2"3/4				



Collari per fissaggio dei tubi rigidi

Serie CP

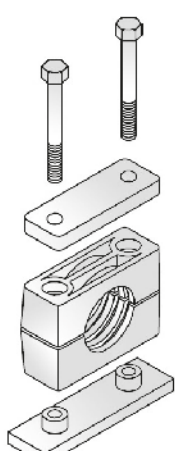
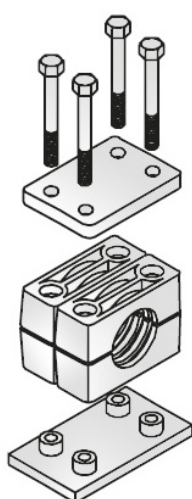
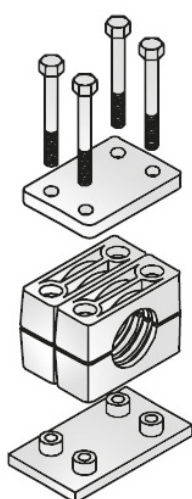
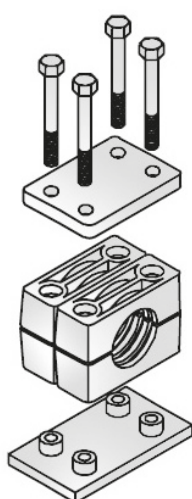
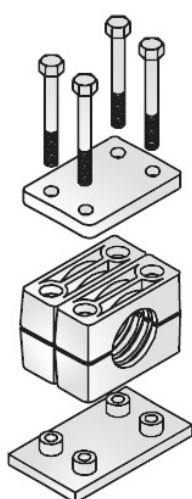
Composizione della versione completa	Tipo misure L x H x P	Codice			diametro esterno tubo		
		Coppia semicollare	Collare completo		mm	pollici GAS	pollici inglesi
			Singolo	Doppio			
 <p>Singolo</p>	CP5 155x118x60	CP5 60,3	CP5 60,3 CS-C	CP5 60,3 CD-C	60,3	2"	-
		CP5 65	CP5 65 CS-C	CP5 65 CD-C	65	-	-
		CP5 66	CP5 66 CS-C	CP5 66 CD-C	66	2"1/4	-
		CP5 70	CP5 70 CS-C	CP5 70 CD-C	70	-	2"3/4
		CP5 73	CP5 73 CS-C	CP5 73 CD-C	73	-	-
		CP5 76	CP5 76 CS-C	CP5 76 CD-C	76	2"1/2	3"
		CP5 80	CP5 80 CS-C	CP5 80 CD-C	80	-	-
		CP5 85	CP5 85 CS-C	CP5 85 CD-C	85	-	-
		CP5 88,9	CP5 88,9 CS-C	CP5 88,9 CD-C	88,9	3"	3"1/2
		CP5 90	CP5 90 CS-C	CP5 90 CD-C	90	-	-
 <p>Doppio</p>	CP6 205x165x80	CP6 100	CP6 100 CS-C	CP6 100 CD-C	100	-	-
		CP6 101,6	CP6 101,6 CS-C	CP6 101,6 CD-C	101,6	-	4"
		CP6 102	CP6 102 CS-C	CP6 102 CD-C	102	3"1/2	-
		CP6 108	CP6 108 CS-C	CP6 108 CD-C	108	-	4"1/4
		CP6 114,3	CP6 114,3 CS-C	CP6 114,3 CD-C	114,3	4"	4"1/2
		CP6 121	CP6 121 CS-C	CP6 121 CD-C	121	-	-
		CP6 126,5	CP6 126,5 CS-C	CP6 126,5 CD-C	126,5	4"1/2	-
 <p>Doppio</p>	CP7 255x200x91	CP7 127	CP7 127 CS-C	CP7 127 CD-C	127	-	5"
		CP7 133	CP7 133 CS-C	CP7 133 CD-C	133	-	5"1/4
		CP7 140	CP7 140 CS-C	CP7 140 CD-C	140	5"	-
		CP7 146	CP7 146 CS-C	CP7 146 CD-C	146	-	-
		CP7 150	CP7 150 CS-C	CP7 150 CD-C	150	-	-
		CP7 152	CP7 152 CS-C	CP7 152 CD-C	152	-	6"
		CP7 159	CP7 159 CS-C	CP7 159 CD-C	159	-	6"1/4
		CP7 168	CP7 168 CS-C	CP7 168 CD-C	168	6"	-
 <p>Doppio</p>	CP8 320x270x120	CP8 168	CP8 168 CS-C	CP8 168 CD-C	168	6"	-
		CP8 177	CP8 177 CS-C	CP8 177 CD-C	177	-	-
		CP8 193	CP8 193 CS-C	CP8 193 CD-C	193	-	-
		CP8 203	CP8 203 CS-C	CP8 203 CD-C	203	-	8"
		CP8 219	CP8 219 CS-C	CP8 219 CD-C	219	8"	-
 <p>Doppio</p>	CP9 470x410x160	CP9 219	CP9 219 CS-C	CP9 219 CD-C	219	8"	-
		CP9 273	CP9 273 CS-C	CP9 273 CD-C	273	10"	-
		CP9 324	CP9 324 CS-C	CP9 324 CD-C	324	12"	-

Collari per fissaggio dei tubi rigidi

Serie CP...B

Pesante con bussola in gomma

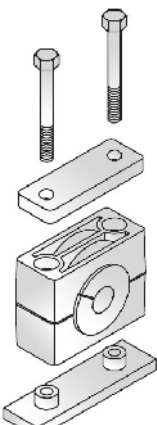
Composizione della versione completa (*)	TIPO misure L x H x P	Codice		diametro esterno tubo			
		Coppia semicollare	Bussola in gomma	mm	pollici GAS	pollici inglesi	
	CP2-B 69x49x30	CP2-B	BG06-2531	6	-	-	
		CP2-B	BG08-2531	8	-	5/16"	
		CP2-B	BG10-2531	10	1/8"	-	
		CP2-B	BG12-2531	12	-	-	
		CP2-B	BG13,5-2531	13,5	1/4"	-	
		CP2-B	BG14-2531	14	-	-	
		CP2-B	BG15-2531	15	-	-	
		CP2-B	BG16-2531	16	-	5/8"	
		CP2-B	BG17,2-2531	17,2	3/8"	-	
		CP2-B	BG18-2531	18	-	-	
		CP2-B	BG19-2531	19	-	3/4"	
		CP2-B	BG20-2531	20	-	-	
		CP3-B 84x60x30	CP3-B	BG08-3831	8	-	-
			CP3-B	BG10-3831	10	1/8"	-
			CP3-B	BG12-3831	12	-	-
CP3-B	BG15-3831		15	-	-		
CP3-B	BG16-3831		16	-	5/8"		
CP3-B	BG18-3831		18	-	-		
CP3-B	BG20-3831		20	-	-		
CP3-B	BG21,3-3831		21,3	1/2"	-		
CP3-B	BG22-3831		22	-	7/8"		
CP3-B	BG25-3831		25	-	-		
CP4-B 117x88x45	CP4-B	BG26,9-3831	26,9	3/4"	-		
	CP4-B	BG28-3831	28	-	-		
	CP4-B	BG30-3831	30	-	-		
	CP4-B	BG32-3831	32	-	1"1/4		
	CP4-B	BG28-5945	28	-	-		
	CP4-B	BG30-5945	30	-	-		
	CP4-B	BG337-5945	33,7	1"	-		
	CP4-B	BG35-5945	35	-	-		
CP5-B 155X118X60	CP4-B	BG38-5945	38	-	1"1/2		
	CP4-B	BG40-5945	40	-	-		
	CP4-B	BG42,4-5945	42,4	1"1/4	-		
	CP4-B	BG48,3-5945	48,3	1"1/2	-		
	CP4-B	BG49-5945	49	-	-		
	CP5-B	BG58-9460	58	-	-		
	CP5-B	BG60,3-9460	60,3	2"	-		
CP6-B 205X165X80	CP5-B	BG63-9460	63	-	-		
	CP5-B	BG65-9460	65	-	-		
	CP5-B	BG70-9460	70	-	2"3/4		
	CP5-B	BG73-9460	73	-	-		
	CP5-B	BG75-9460	75	2"1/2	-		
	CP6-B	BG75-122580	75	-	-		
CP6-B 205X165X80	CP6-B	BG80-122580	80	-	-		
	CP6-B	BG85-122580	85	-	-		
	CP6-B	BG90-122580	90	3"	-		
	CP6-B	BG100-122580	100	-	-		
	CP6-B	BG102-122580	102	3"1/2	-		
	CP6-B	BG103-122580	103	-	-		

(*) **ATTENZIONE:** I collari con bussola sono forniti sfusi, per ottenere la versione completa ordinare separatamente:

- n° 1 coppia semicollare
- n° 1 bussola in gomma

- n° 1 piastra inferiore **P CP...** (vedi accessori)
- n° 1 piastra superiore **PS CP...** (vedi accessori)
- n° 2 viti **TE.CP** (vedi accessori)



Collari per fissaggio dei tubi rigidi

ACCESSORI

Piastra inferiore

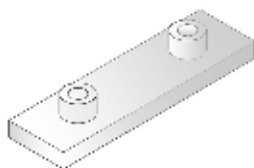

tipo collare	Codice	
	singolo	doppio
CP1	P-CP1	CDP-CP1
CP2 - CP2 B	P-CP2	CDP-CP2
CP3 - CP3 B	P-CP3	CDP-CP3
CP4 - CP4 B	P-CP4	CDP-CP4
CP5 - CP5 B	P-CP5	CDP-CP5
CP6 - CP6 B	P-CP6	CDP-CP6
CP7	P-CP7	CDP-CP7
CP8	P-CP8	CDP-CP8
CP9	P-CP9	CDP-CP9

Piastra superiore

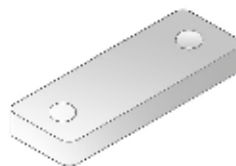

tipo collare	Codice	
	singolo	doppio
CP1	PS-CP1	CDPS-CP1
CP2 - CP2 B	PS-CP2	CDPS-CP2
CP3 - CP3 B	PS-CP3	CDPS-CP3
CP4 - CP4 B	PS-CP4	CDPS-CP4
CP5 - CP5 B	PS-CP5	CDPS-CP5
CP6 - CP6 B	PS-CP6	CDPS-CP6
CP7	PS-CP7	CDPS-CP7
CP8	PS-CP8	CDPS-CP8
CP9	PS-CP9	CDPS-CP9

Piastra inferiore allungata

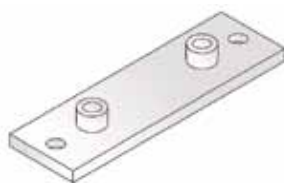

tipo collare	Codice	
	singolo	doppio
CP1	PL-CP1	CDPL-CP1
CP2 - CP2 B	PL-CP2	CDPL-CP2
CP3 - CP3 B	PL-CP3	CDPL-CP3
CP4 - CP4 B	PL-CP4	CDPL-CP4
CP5 - CP5 B	PL-CP5	CDPL-CP5

Vite testa esagonale

per montaggio con piastra superiore



tipo collare	Codice	misura
CP1	TE-CP1	M10x45
CP2 - CP2 B	TE-CP2	M10x60
CP3 - CP3 B	TE-CP3	M10x70
CP4 - CP4 B	TE-CP4	M12x100
CP5 - CP5 B	TE-CP5	M16x130
CP6 - CP6 B	TE-CP6	M20x190
CP7	TE-CP7	M24x220
CP8	TE-CP8	M30x300
CP9	TE-CP9	M30x450

Piastra testa esagonale alta con filettatura interna

per montaggio di collari sovrapposti



tipo collare	Codice	misura
CP1	VA-CP1	M10x49
CP2 - CP2 B	VA-CP2	M10x65
CP3 - CP3 B	VA-CP3	M10x75
CP4 - CP4 B	VA-CP4	M12x108
CP5 - CP5 B	VA-CP5	M16x139
CP6 - CP6 B	VA-CP6	M20x190
CP7	VA-CP7	M24x240
CP8	VA-CP8	M30x315

Piastrina di bloccaggio per VA

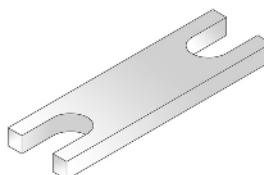

tipo collare	Codice
CP1	PB-CP1
CP2 - CP2 B	PB-CP2
CP3 - CP3 B	PB-CP3
CP4 - CP4 B	PB-CP4
CP5 - CP5 B	PB-CP5
CP6 - CP6 B	PB-CP6
CP7	PB-CP7
CP8	PB-CP8

Binari

Binario per collari

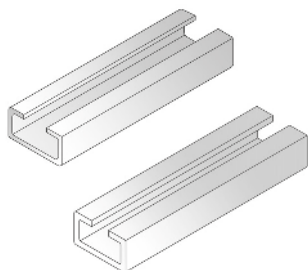

serie	tipo collari	Codice	misura mm	lunghezza mt
Standard	C, CF, CB	BB 2814	28x14	2
		BB 2830	28x30	2
Pesante	CP, CP-B	BB-P 4022	40x22	2

Dado per fissaggio collari al binario

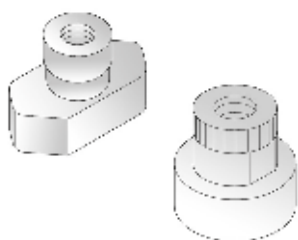

serie	tipo collari	Codice	misura mm
Standard	C1÷C9, CF1	DF M6	M 6 x 1
	CF2÷CF5	DF M8	M 8 x 1,25
Pesante	CP1÷CP3	DF-P M10	M 10 x 1,5
	CP4	DF-P M12	M 12 x 1,75

Nota: Per i collari con bussola in gomma CB e CP...B riferirsi alle corrispondenti serie Standard o Pesante

Anello in gomma per posizionare il dado DF sul binario



serie	tipo collari	Codice
Standard	C, CF, CB	AG
Pesante	CP, CP-B	AG-P

ESEMPIO DI MONTAGGIO

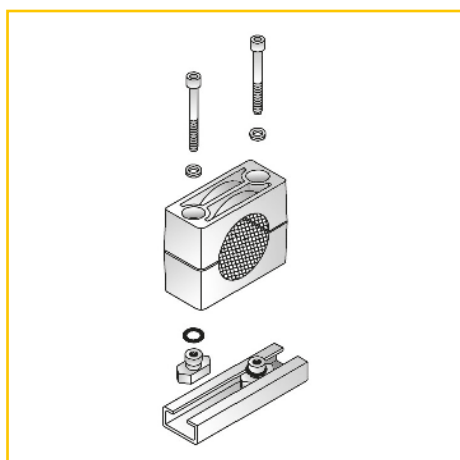

Collari serie C

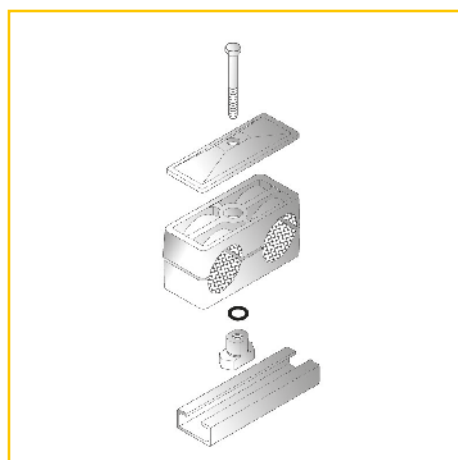

Collari serie CF

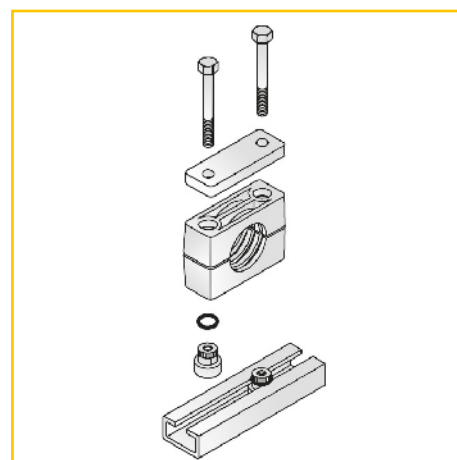

Collari serie CP



Cavallotti

Serie CL

Serie leggera

Completo di 2 dadi e due rondelle (a richiesta con 4 dadi e 4 rondelle)

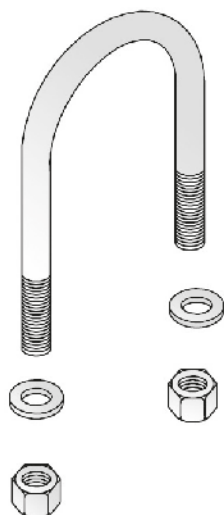

Codice	Ø tubo pollici GAS	misure		
		filetto	altezza	interasse
CL01-C/2	1/8"		36	17
CL02-C/2	1/4"		39	20
CL03-C/2	3/8"		42	24
CL04-C/2	1/2"	M6	48	28
CL05-C/2	3/4"		52	33
CL06-C/2	1"		60	40
CL07-C/2	1"1/4		68	49
CL08-C/2	1"1/2		80	57
CL09-C/2	2"		92	69
CL10-C/2	2"1/2		108	85
CL11-C/2	3"	M8	120	97
CL12-C/2	3"1/2		137	110
CL13-C/2	4"		149	123
CL14-C/2	5"		176	148
CL15-C/2	6"		211	178
CL16-C/2	8"	M10	263	230
CL17-C/2	10"		317	284
CL18-C/2	12"		383	340
CL19-C/2	14"	M16	415	372
CL20-C/2	16"		467	424

Serie CM

Serie media

Completo di 2 dadi e due rondelle (a richiesta con 4 dadi e 4 rondelle)

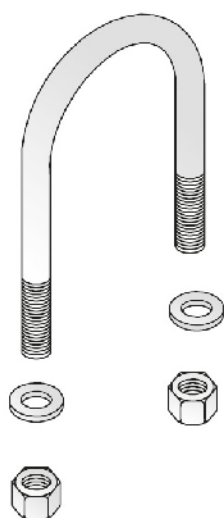

Codice	Ø tubo pollici GAS	misure		
		filetto	altezza	interasse
CM04-C/2	1/2"		59	30
CM05-C/2	3/4"	M8	63	35
CM06-C/2	1"		71	42
CM07-C/2	1"1/4		79	51
CM08-C/2	1"1/2		91	59
CM09-C/2	2"	M10	103	71
CM10-C/2	2"1/2		119	87
CM11-C/2	3"		131	99
CM12-C/2	3"1/2		153	114
CM13-C/2	4"	M12	167	127
CM14-C/2	5"		191	152
CM15-C/2	6"		219	180
CM16-C/2	8"	M16	282	236
CM17-C/2	10"		336	290
CM18-C/2	12"		397	344
CM19-C/2	14"		429	376
CM20-C/2	16"	M20	481	428
CM21-C/2	18"		533	480
CM22-C/2	20"		583	530
CM23-C/2	24"		685	632





STIMA

Stima S.p.A - Via Giudei, 33/35 - 40050 FUNO (BO)
Tel. 051 8651511 Fax 051 860263 - www.stima.it - e-mail: group@stima.it